

Didactic concept
GUNT DigiSkills 3

Digitalisation in the world of work – new requirements for education

Designing training in industrial metalworking and electrical professions

Our leaning projects help you to implement the new requirements

Didactic concept for a complex learning project

**Preventive maintenance in production:
Replacing a gearbox**

Planning training elements and teaching courses

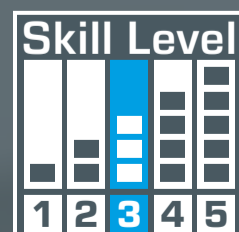

Table of contents

1	Selected process steps	04
1.1	Process step 1, Maintenance reporting Condition monitoring & predictive maintenance	04
1.2	Process step 3, Replacing the gearbox	06
1.3	Process steps 6 and 8, Scheduled disassembly and reassembly of the gearbox	08
1.4	Process step 7, Procurement of spare parts	10
1.5	Process step 9, Functional test for quality assurance	11
2	What trainees say	12
3	Example presentation of selected exercises	14
3.1	Machine condition monitoring	14
3.1.1	Overall aim of the exercise	14
3.1.2	Detailed description of the procedure	14
3.1.3	Learning objectives – competence modules	15
3.2	Assembly/disassembly of a gearbox	16
3.2.1	Overall aim of the exercise	16
3.2.2	Examples with concrete steps	16
3.2.3	Learning objectives – competence modules	17
3.3	Functional test for quality assurance	18
3.3.1	Overall aim of the exercise	18
3.3.2	Examples with concrete steps	18
3.3.3	Understanding the mechanical structure of the test stand and recognising basic functions	18
3.3.4	The control system	18
3.3.5	Installation of a gearbox and alignment of the whole system	18
3.3.6	Occupational safety – equipment safety	18
3.3.7	Connection of PC and mobile devices	19
3.3.8	Test results	19
3.3.9	Learning objectives – competence modules	19
3.4	Producing a spare part through additive manufacturing	20
3.4.1	Overall aim of the exercise	20
3.4.2	Detailed description of the procedure	20
3.4.3	Learning objectives – competence modules	21
3.5	Electrical engineering – control engineering	22
3.5.1	Overall aim of the exercise	22
3.5.2	Detailed description of the procedure	22
4	Product list and tender specifications	23
5	Summary – outlook	24

Foreword

More than any other group, the industrial metal-working and electrical professions are in the spotlight when it comes to **digitalisation** and **Industry 4.0**. Education must respond to the new requirements with a concrete implementation of the Industry 4.0 relevant fields of competence and training content. Conventional and innovative techniques coexist and must both be mastered. GUNT can help you with these complex educational tasks. Our practical, work process-oriented learning projects, which are perfectly suited to developing digital skills, are available to you in the form of the **GUNT DigiSkills** product line.

There is no need for expensive investments in complex networked model systems for manufacturing and robotics in your laboratories and workshops. With our GUNT DigiSkills concepts, we show you that training can be easier, cheaper and more tangible.

The motivation and learning progress of your students/trainees will reward you as a trainer or as a teacher if you use GUNT DigiSkills learning projects.

Notes:

This document does not make any scientific claims. It is designed to be practical, as a direct stimulus for modern teaching and process-oriented education. The digitalisation goals apply everywhere: in training organisations as well as in vocational schools or colleges.

The author's aim is to generate dialogue with you.

The GUNT DigiSkills 3 learning project

In a production area, the machines and systems should have 24/7 availability. Critical parts and components are monitored by sensors (condition monitoring) as part of the concept of predictive maintenance and the time when maintenance or replacement is needed is defined in this way.

As a starting point for this learning project, we use the real MT 174 Sorting plant. Three gearboxes are installed in the sorting plant, which will help us visualise the process steps of the entire learning project. At the beginning of the process, the service team of the firm receives the message and the order to replace a certain gearbox in a production plant. In order to avoid long downtimes of the production plant, essential components such as gearboxes are replaced quickly and immediately. The removed gearbox is overhauled as quickly as possible and is then available again as a tested component.

The entire process, from notification of the maintenance action, replacement of the gearbox, overhaul of the removed gearbox, disassembly, procurement of spare parts, reassembly, functional check and the final report, is IT-based using a wide range of digital elements and technologies. The process of plant maintenance can be organised within an ERP system.

Pursuing a learning project such as GUNT DigiSkills 3 in the vocational school or colleges or in the training organisation entirely in an ERP system is only possible in certain cases. The important basic idea, the use of a networked information system (ERP), can be demonstrated and understood very clearly, for example using an Excel application.



About the author

Rudolf Heckmann is Managing Director at G.U.N.T. Gerätebau GmbH, and is responsible for programme development and didactic concepts. Education: Mechanical engineering and physics, 10 years teaching experience in the vocational/technical sector. Extensive scientific work on engineering pedagogy and subject didactics. Founder of the international GUNT Technical Academy.

GUNT DigiSkills learning projects

Skill Level	1 Engineering drawing – Technical communication
	2 Dimensional metrology
	3 Preventive maintenance
	4 Energy efficiency in compressed air systems
	5 Robotics and automation

The entire preventive maintenance process

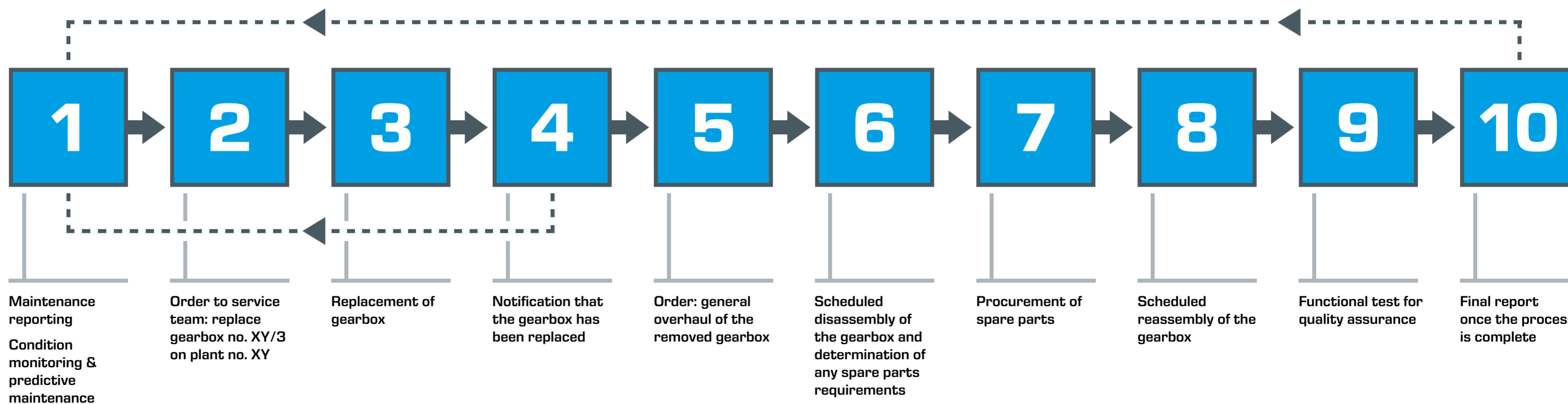

The process shown here is just an example. Individual process steps may well be different and the terminology used may also differ in different companies.

1 | Selected process steps

1.1 | Process step 1

Maintenance reporting Condition monitoring & predictive maintenance



Technical description

In larger plants, scheduled machine condition monitoring is a standard process. The terms **condition monitoring** and **predictive maintenance** have become established in specialist circles to describe this process. Extensive software applications exist to help manage machine condition monitoring. The process also includes the remote transmission of data and the generation of maintenance and service orders.

The maintenance notification is triggered:

- **time-controlled**, i.e. as soon as the end of a maintenance interval is reached
- **sensor-controlled**, i.e. when a limiting value is reached

Resources for technical education

As a starting point for the didactically structured process of preventive maintenance, we use the **MT174 Sorting plant as the industrial plant**. The plant control system (PLC) reports the need for maintenance. A certain drive unit, gearbox and electric motor are to be replaced.

The sorting plant offers very versatile approaches and practical introductions to many important topics.

At this point, we will limit ourselves to showing you how the MT174 Sorting plant can be used for process step 1. We will look at the resources and technical possibilities that are available to you. Suggestions for specific exercises follow later.



MT174 Sorting plant

The three gearboxes installed in MT174 are available in the identical design as assembly exercises.

- **MT120 Assembly exercise: spur gear**
- **MT122 Assembly exercise: planetary gear**
- **MT123 Assembly exercise: spur and worm gear**

Extensive digital information and exercise material for these assembly exercises is available in the GUNT Media Center; accessible via QR code.

Maintenance, time-controlled

The integrated Siemens PLC with touch screen is used to operate and control the plant. The intuitive user interface offers an extensive menu area for maintenance. For this purpose, the plant is switched from operation to training. Training mode simulates time-controlled and sensor-controlled maintenance work. The menu also offers a sensor-controlled version of monitoring to monitor the drive for the rotary storage table.

Comparable tasks are available for the conveyor belt with dosing hopper and drum screen components.

An **augmented reality** interface for mobile devices is also available to help visualize the individual steps of the maintenance work. See process step 3.

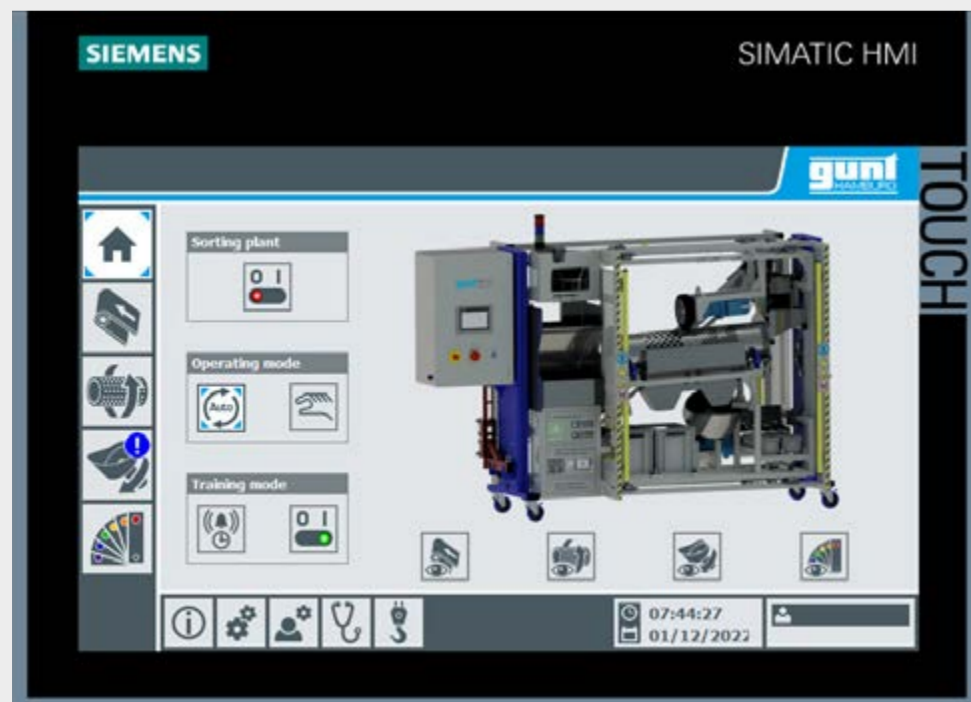

maintenance work required on the drive train

maintenance steps for lubricating the shaft joint

time-controlled maintenance interval: Maintenance on the rotary storage table sub-system is displayed



Maintenance, sensor-controlled

We take a closer look at the drive for the rotary storage table. The asynchronous motor is connected to the spur and worm gear mechanism. We will follow up on this gearbox in the course of our learning project.

Sensor-controlled maintenance work is simulated in training mode. For this purpose, the gear is equipped with an electric heater and a temperature sensor. The oil sump of the gear can be heated electrically so that the lubricating oil temperature rises and reaches a limit value. This triggers preventive maintenance with the message: Replace drive.

In the training mode of the user interface, various setting and display options are offered for this purpose. All options for flexible data handling are available.

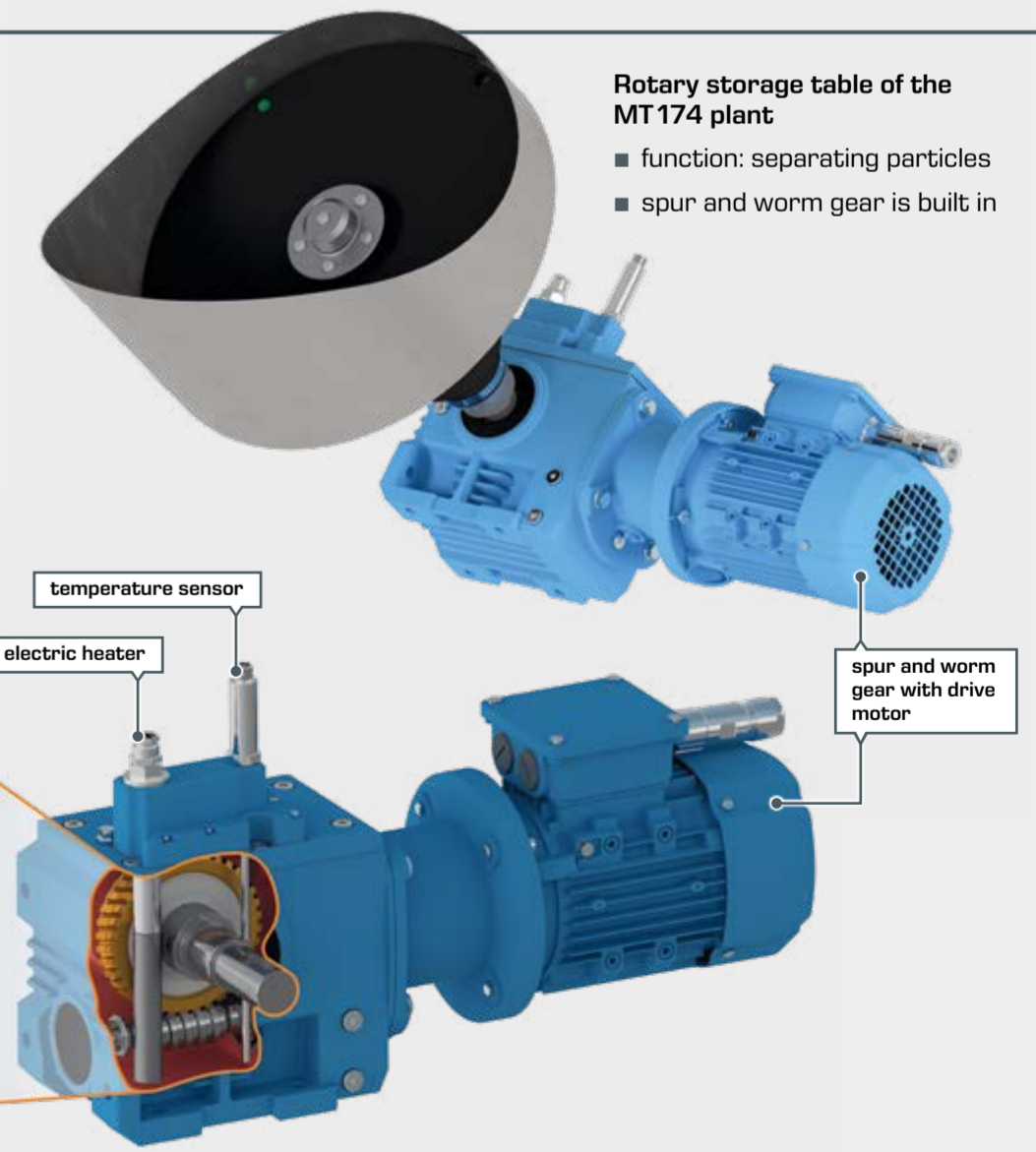

Rotary storage table of the MT174 plant

- function: separating particles
- spur and worm gear is built in

1 | Selected process steps

1.2 | Process step 3

Replacing the gearbox



Technical description

The creation and transmission of the service order is covered in process step 2 and is not dealt with here. Here we look at the procedure from the point of view of the service team: the order to replace a specific gearbox in the plant has been sent.

The primary aim is to keep plant downtime to an absolute minimum when maintenance is required. That is why the service team has a ready-to-install, tested replacement kit: Spur and worm gear with drive motor. The removed drive train is then thoroughly overhauled and is available again as a tested unit if required.

Resources for technical education

Replacing a gearbox is a standard procedure. Nevertheless, the mechanics (in this case students/trainees) will prepare themselves before they start working on the industrial plant. In the **traditional way**, technical documents are available to them, e.g. assembly drawing, parts list, assembly/disassembly instructions, tool and jig list, notes on work safety. You can access these documents from the GUNT Media Center via QR code in the GUNT DigiSkills 3 learning project.

We offer you and your students/trainees the option to take the **virtual route** with support from Augmented Reality (AR), as another way to carry out the service process.

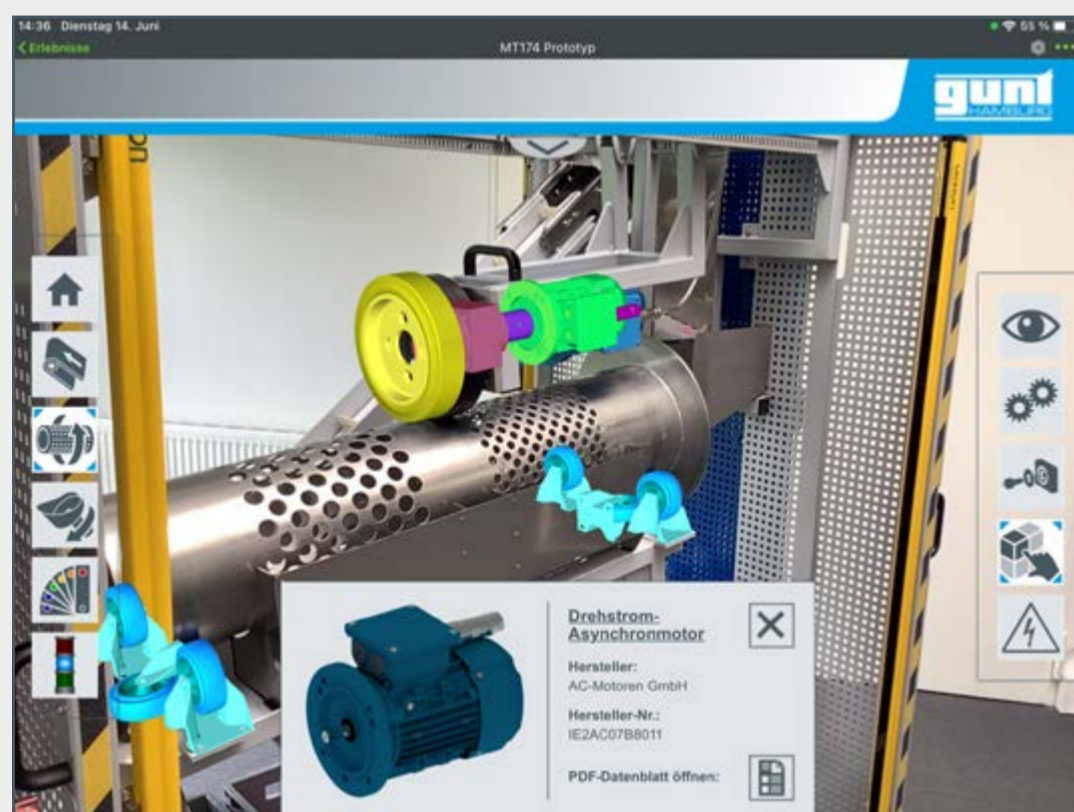

Both ways – real and virtual – are presented on these two pages.

The virtual way



Using an Augmented Reality (AR)

environment: Students/trainees must follow the steps below to access the AR environment:

- 1 Install the Vuforia View app on smartphone or tablet free of charge.   
- 2 Open the Vuforia View app and scan the QR code to enter the specific server address. This will allow access to GUNT's AR server.
- 3 Now the AR environment for MT174 can be accessed in the app. All assembly steps are visualised in the AR environment.

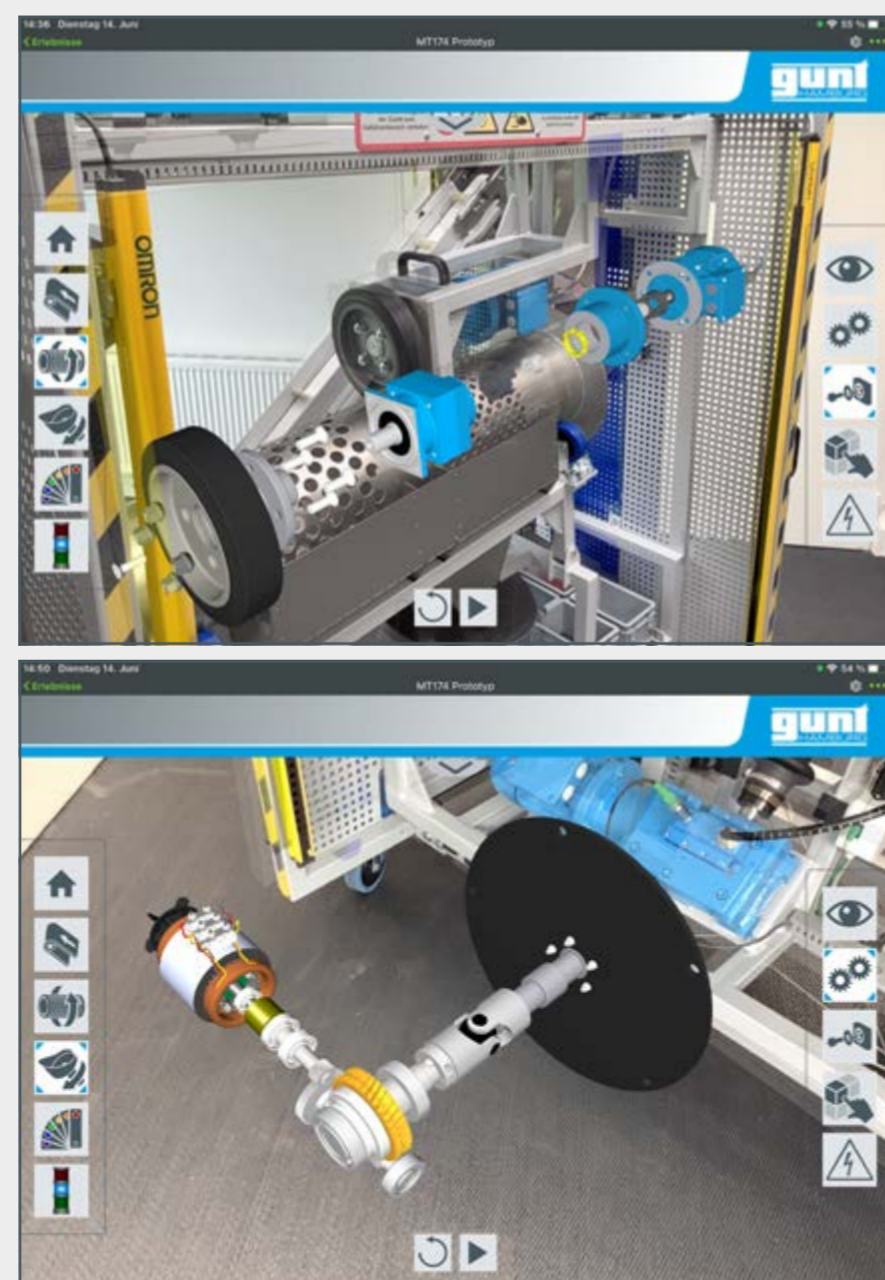

The real-world way

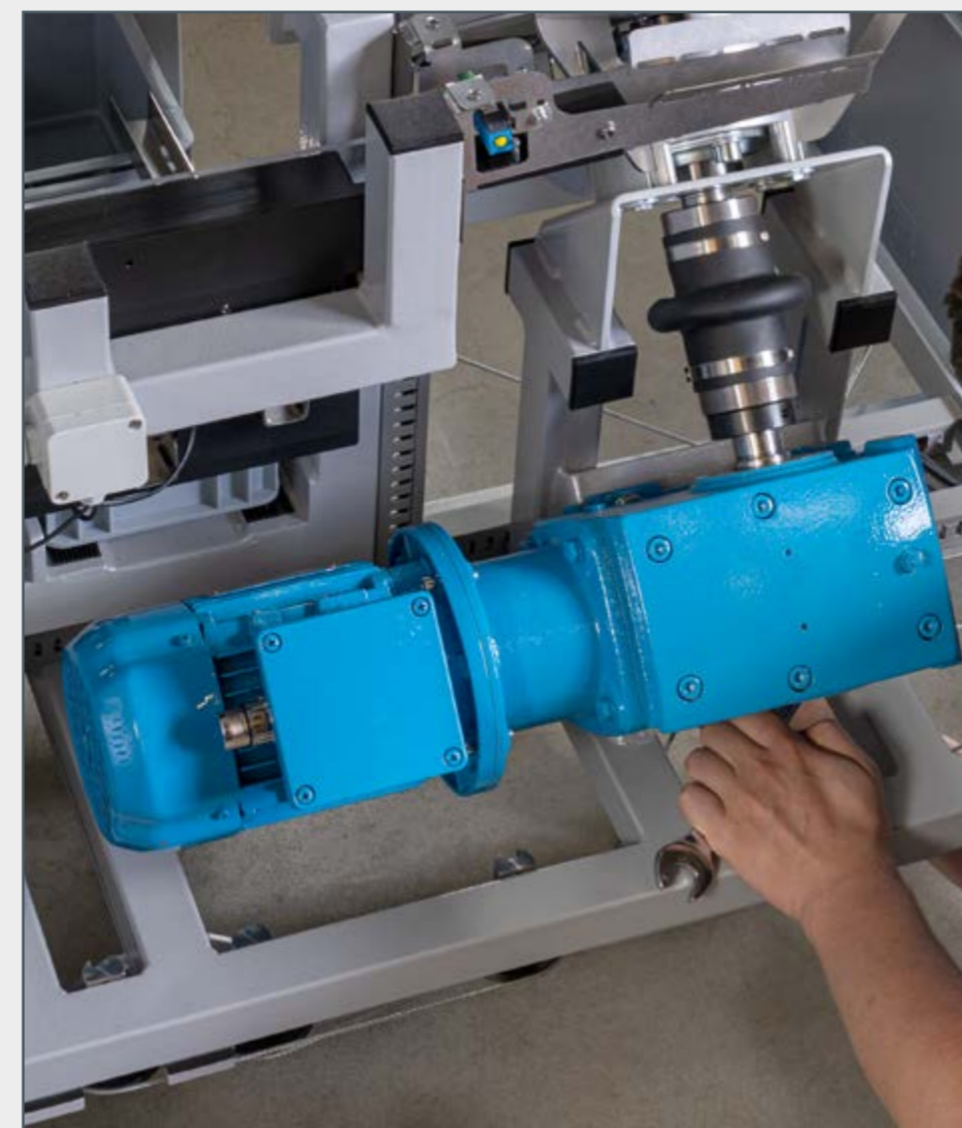

undo the threaded joint between the drive train and the frame in MT174

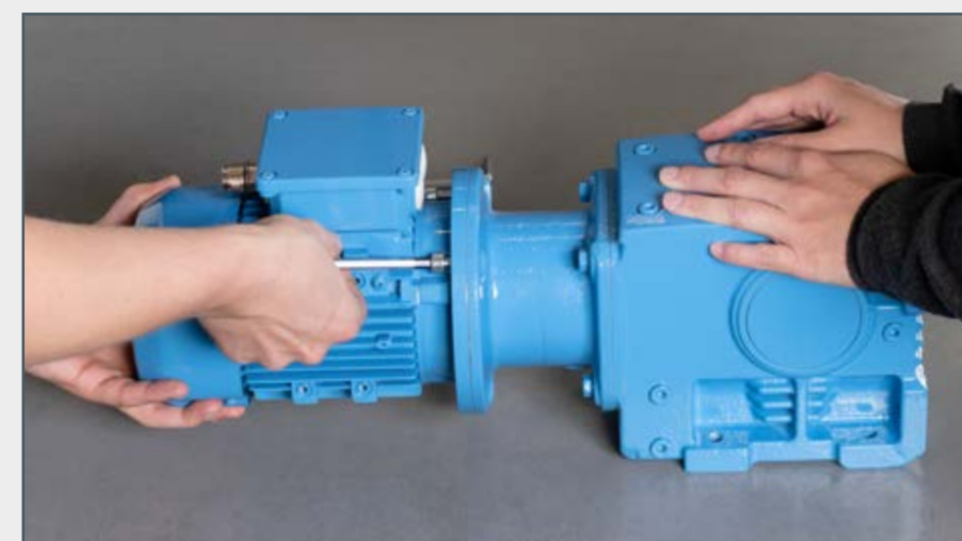

dismantle the drive train

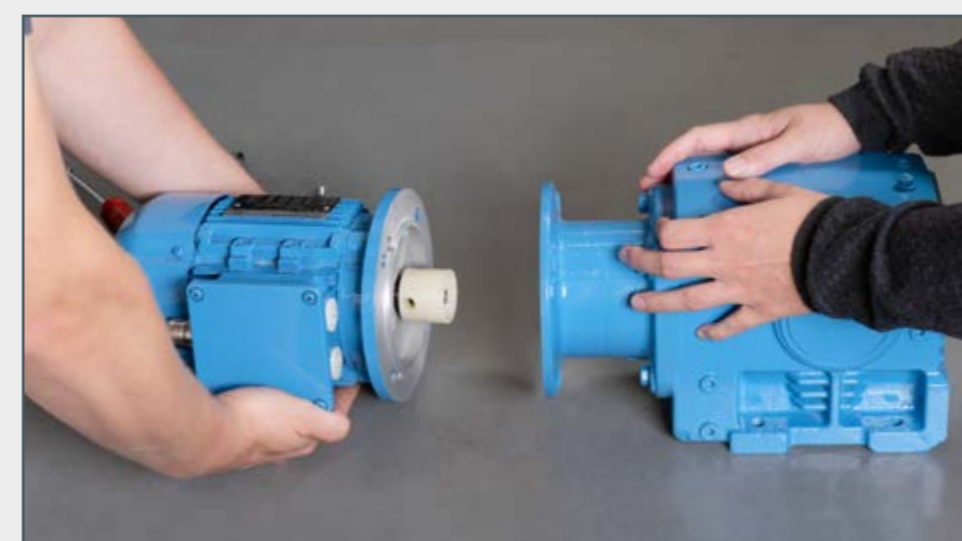

motor and gearbox as individual components



discuss the task at hand: scheduled disassembly of the gearbox

Manual activity

The entire drive train can be removed from the MT174 Sorting plant:

- 1 Disconnect power supply for motor and heater as well as cable for temperature measurement. Check that there is no voltage using the 5 safety rules. The cables are equipped with plug connections for easy disassembly.
- 2 Undo the threaded joint between the drive train and the frame in MT174.
- 3 The entire drive train, consisting of the gearbox with flange-mounted motor and cardan joint, is lifted out of the sorting plant by crane.
- 4 The drive train is disassembled to such an extent that the motor and gearbox are present as individual components.
- 5 If the gearbox is to be disassembled into its individual components, a change is made at this point to the associated MT123 Assembly exercise: spur and worm gear.

Advantage: By combining MT174 with the assembly exercises, the students/trainees can carry out a complete maintenance or servicing process in a manual/real-world fashion. The gearbox is placed in a realistic, higher-level context through its integration into the drive train of MT174.

1 | Selected process steps

1.3 | Process steps 6 and 8

Scheduled disassembly and reassembly of the gearbox



Technical description

The spur and worm gear removed from the sorting plant is to be fully overhauled in order to be available again as a tested, fully functional component for subsequent, renewed maintenance.

For process steps 6 and 8, there is a defined work order, to which technical information documents can be attached. The individual work steps for scheduled disassembly and assembly are divided into:

- dismantling the gearbox
- cleaning and inspection
- repair with procurement of spare parts
- careful reassembly of the gearbox

Resources for technical education

For didactic reasons, the spur and worm gear for driving the rotary storage table from our MT174 industrial plant has an electric heater and a temperature sensor. For a convenient teaching procedure, we therefore use our MT123 Assembly exercise: spur and worm gear

exercise: spur and worm gear for disassembly and assembly. The assembly kit included offers an identically constructed gearbox as that installed in the

MT174 Sorting plant. However, the kit in the assembly exercise is specially prepared for easy assembly/disassembly, suitable for classroom desks.

Hardware: MT123 Assembly exercise: spur and worm gear



The gearbox is available in a perfect organisational structure. Everything is prepared for multiple use. Best transport options.



MT123 Assembly exercise: spur and worm gear



clear storage system with labelling

complete assembly tool kit included

Digital: GUNT Media Center

As a customer you have unlimited access to the digital content of your project.

- all files directly via the Internet browser on smartphone, tablet or PC
- no other software required
- no licences, full rights of use for your school
- continuous updating and expansion of data, available to customers and absolutely free of charge



simply scan the QR code and you'll be taken straight to the GUNT Media Center



3D drawings for all modules



assembly and disassembly videos

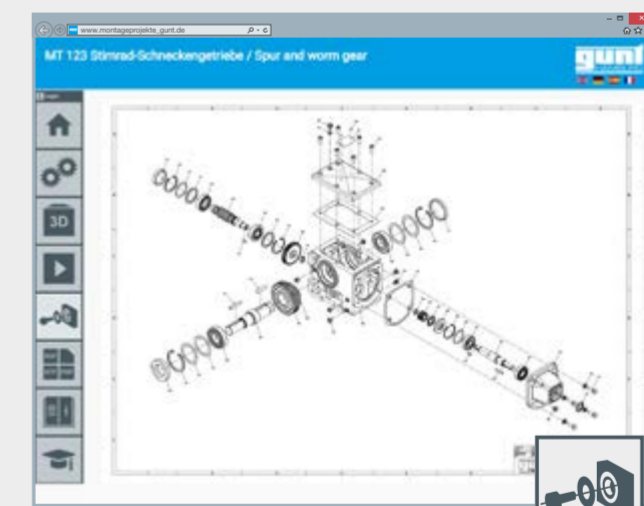

exploded drawings

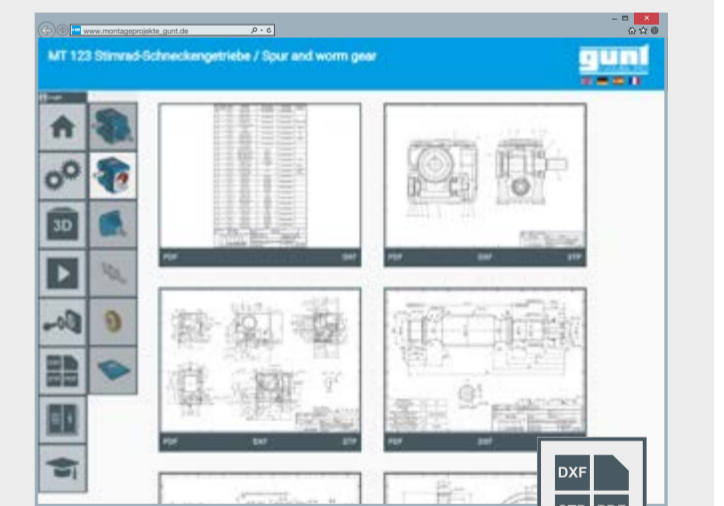

assembly view

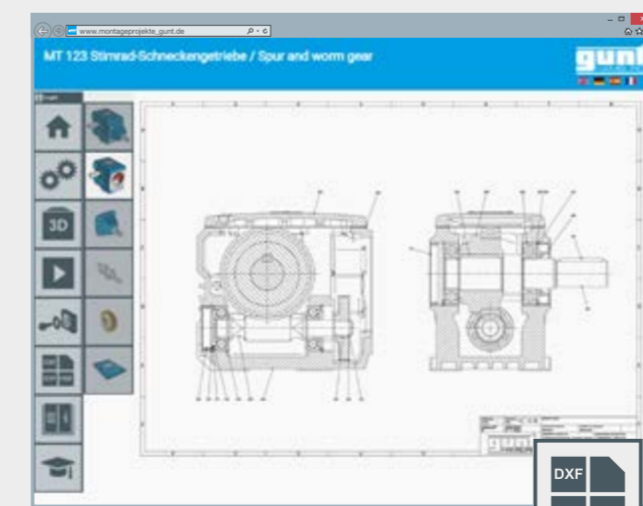

engineering drawings and parts lists



manuals



prepared exercises

1 | Selected process steps

1.4 | Process step 7

Procurement of spare parts



Technical description

In a real business environment, the **maintenance and repair service department** is often integrated into the **ERP system**.

From there, for the component under consideration it is easy to find out if that component is:

- a standard part?
- a drawing part?
- available in stock?
- to be procured?
- to be produced?

At this point, we play a little with didactic variations in order to arrive at an interesting teaching sequence.

We find out: a certain component from our gearbox has to be manufactured because it is not available in stock and procuring it externally would take too long. Due to time constraints, we decide to manufacture it through additive manufacturing.

Resources for technical education



scan the QR code to access the article in the GUNT Media Center

select the required data in the GUNT Media Center

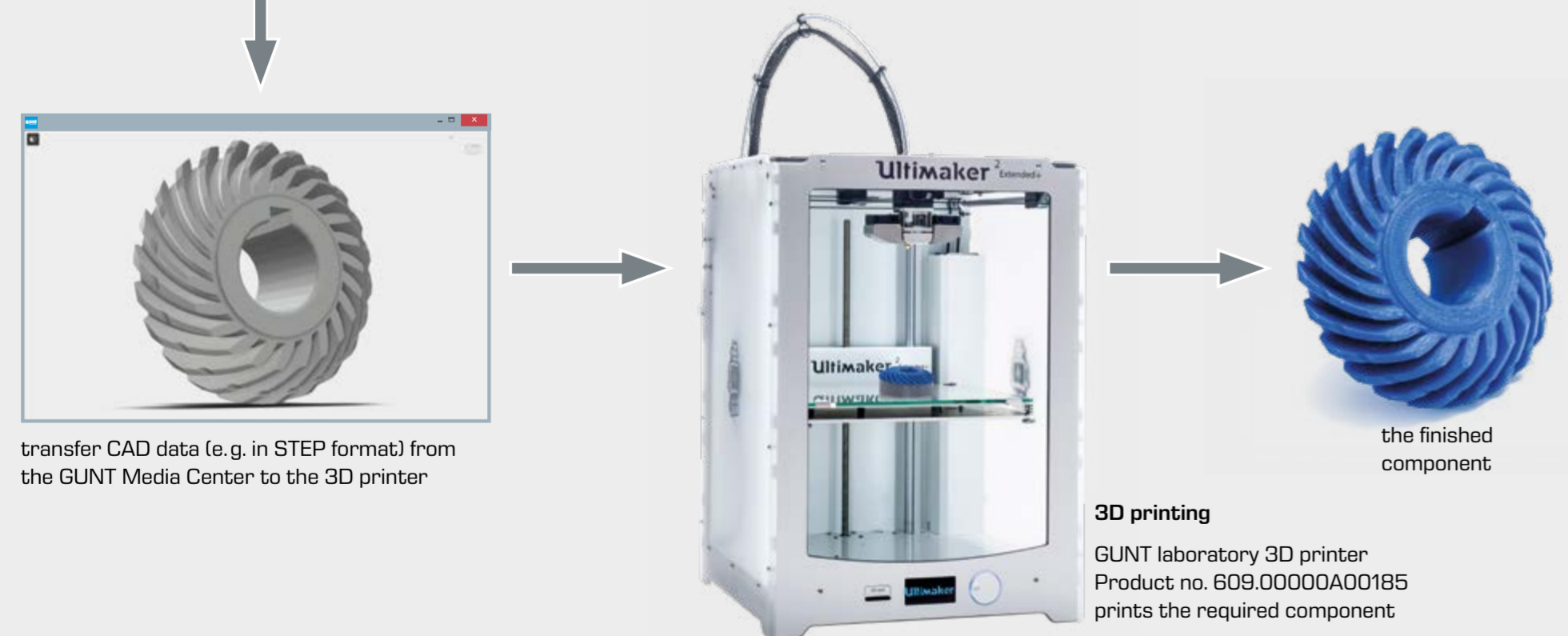

transfer CAD data (e.g. in STEP format) from the GUNT Media Center to the 3D printer

3D printing
GUNT laboratory 3D printer
Product no. 609.0000A00185
prints the required component

1.5 | Process step 9

Functional test for quality assurance



Technical description

After successful reassembly, the gearbox is subjected to a functional test under real-world conditions:

- over a certain period of time
- under certain loads
 - ▶ the speed remains constant and the load torque is increased in steps
 - ▶ the load torque remains constant and the entire speed range is passed through in steps.

The test results can be part of the 'Done' message.

Resources for technical education

In order to conclude the whole process in the classroom in a practical way, we use the **MT 173 Test stand for gears**.

The rebuilt gearbox is placed in the test stand, including alignment and fitting of protective covers. In addition to the main goal of subjecting the rebuilt gearbox to a defined load test, the students/trainees should become familiar with the technical set-up and function of the test stand itself. This is a rich resource for versatile technical expansions.

The mechanical structure

- a speed-controlled asynchronous motor serves as the drive
- a magnetic particle brake serves as the controllable load

Sensors

There are sensors for speed and torque on both the input and output sides.

Central control system

A PLC with touch screen manages all control tasks and offers many supporting menus to conduct tests, display test results and graphical aids for the mechanical structure.

Communication

With its own WLAN, the PLC offers the option of allowing several users to participate via mobile devices by means of screen mirroring. Integration into the customer network is also possible.

Provision of information

Via QR code you can access comprehensive information and teaching material in the GUNT Media Center, which GUNT makes available to you when you purchase the MT173 test stand.



2 | What trainees say



Interview with apprentices, 3rd year industrial mechanics

Walter and Henry*, industrial mechanics in their 3rd year

What task were you given?

Our topic is maintenance and preventive maintenance. We want to find out which maintenance steps are defined for the sorting plant.

What sources of information do you have at your disposal?

The control system itself. We go through the menus. There is an area in the control system where the various maintenance tasks are monitored. That's where we find the most important points. Then we also use our tablet or iPhone. We open an app and can look at the module itself to see exactly what needs to be done. This is done via AR, augmented reality.

How do you document and communicate the results of your work?

We make a short report and include photos or screenshots. We save the PDF file for ourselves and it goes to our trainer at the same time.

How much time did you have for this task?

Two hours at the plant and about three hours for the documentation.

What do you like most about this work?

We see how the whole thing works together. We have clear tasks and can do them independently. We think it's good and important that we can work in a modern, digitally focused environment.

Can you also put the sorting plant into operation and run it?

Absolutely, no problem.

And what will happen next?

In the next few days we'll be tackling certain maintenance tasks in real terms.

Do you ever talk about your training at home or with friends?

We don't talk about it so much, but we do show our own videos or photos.



Interview with trainees, 1st year industrial mechanics

Robert and Jenny*, 1st year industrial mechanics

What is your task today?

The gearbox has a mechanical defect caused by wear. We already suspect which components are affected. We disassemble the gearbox, identify the parts to be replaced and then reassemble the gearbox until it is like new.

How and in what form did you receive your task?

We all use the GUNT Media Center. Our instructor got the assignment from there and made the PDF file available to us in our document folder.

How did you inform yourselves before you started dismantling the gearbox?

We have a QR code that takes us to the GUNT Media Center. You really can find everything there: Videos for assembly/disassembly, drawings for individual parts and modules in all file formats and parts lists. We can display, print or download anything we want to use. Of course, we know that less paper is better.

How do you complete your exercise?

There are questions and tasks that we work on in a given PDF format and save when we are sure we are right. In between, we talk a lot with the instructor.

How much time did you need?

About 3 hours, including cleaning up. We did the whole exercise together.

What did you like about it?

It's a lot of fun to do practical, manual work. We can clearly see what we have learned. Jenny: I think it's great that we're also learning foreign languages, technical terms. Everything in the GUNT Media Center is multilingual.

And what will happen next?

We want to look at the entire set of drawings and the parts lists for the gearbox. This will also include material designations and standard parts. Next week.

* For data protection reasons we have only published the first names of the persons involved. Those involved have agreed to this publication.

* For data protection reasons we have only published the first names of the persons involved. Those involved have agreed to this publication.

3 | Example presentation of selected exercises

3.1 | Machine condition monitoring

This exercise is mainly related to **process step 1**.

3.1.1 | Overall aim of the exercise

In our practical example, we assume that a message is received from the plant: Gearbox xy/3 reached limit data and should be replaced with a new or good as new gearbox as part of preventive maintenance. This brings us to the topic of **machine condition monitoring**.

In our exercises, the **MT174 Sorting plant** represents our industrial plant. Of course, this plant does not run in continuous operation or under loads. Therefore, at this specific point there is certain simulation.

The Siemens PLC installed in the plant issues time-dependent or limit-data-dependent messages for certain maintenance steps. This also applies to the task: Replace gearbox xy/3.

With this exercise, the students/trainees should be able to understand and explain the input information on which preventive maintenance depends and where it comes from.

To get a deeper understanding of machine condition monitoring based on vibration analysis, we suggest an additional, specific parallel exercise: **PT501 Roller bearing faults**.

The experimental results lead to clear definitions of damage based on the analysis of vibration patterns.

3.1.2 | Detailed description of the procedure

Use of the MT174 Sorting plant

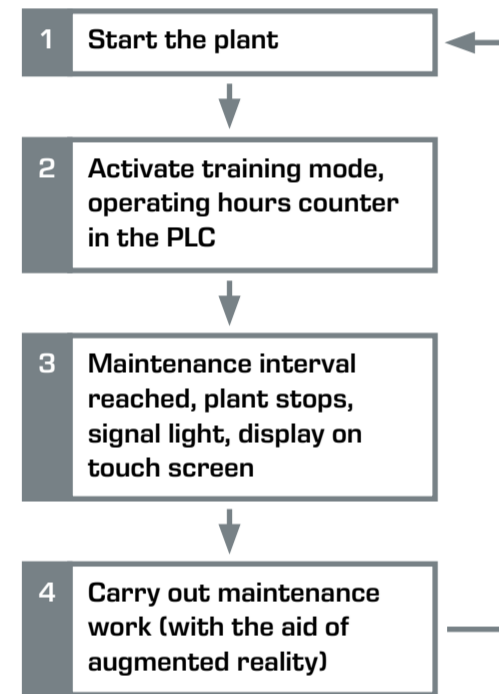

MT174 Sorting plant

- maintenance steps are prepared and can be carried out virtually or for real
- augmented reality training environment

Replacing a gearbox is the largest and most complex exercise. Smaller tasks are also available:

- conveyor belt with dosing hopper: replacing a V-belt
- drum screen: replacing the sprocket of the coupling
- rotary storage table: lubricating the shaft joint

Example
Replacing the sprocket of the coupling on the drum screen

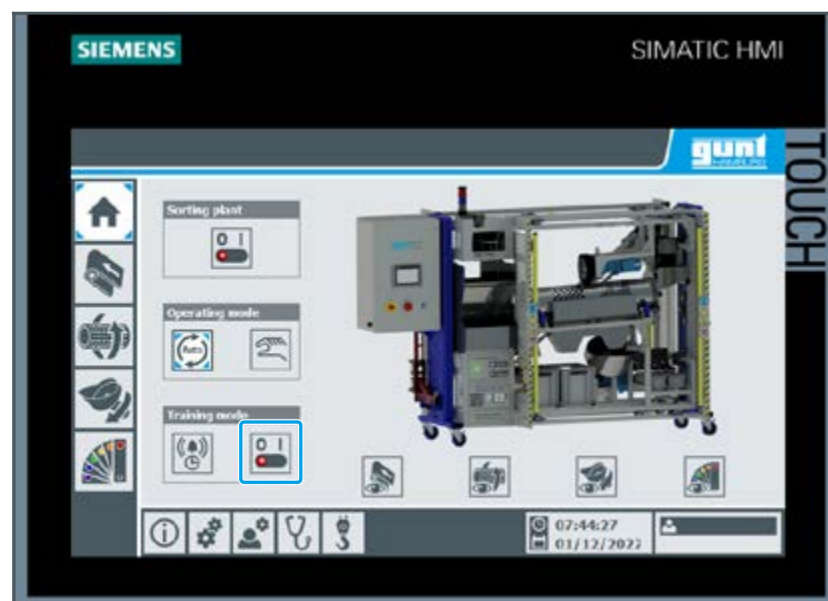

Switch on training mode on the touch screen. Operating hours counter is located in the PLC. The maintenance intervals for the various sub-systems can be **simulated**, i.e. adjusted.

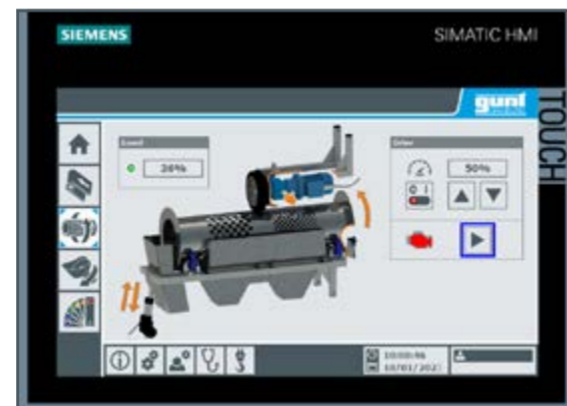

Maintenance on the drum screen

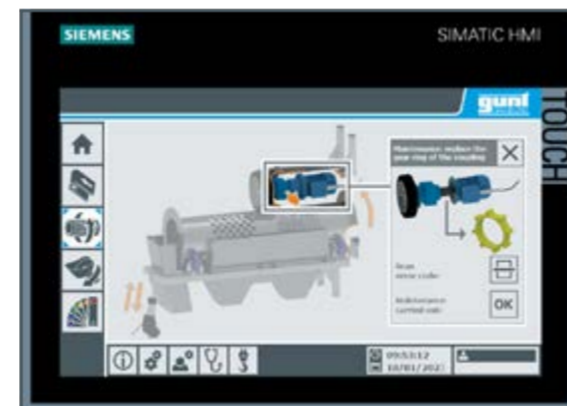

An overview of the situation is accessed via the menu on the touch screen. All further details directly on the drum screen via our augmented reality.



Here we suggest familiarising yourself with the planetary gear installed in the drum screen better as a separate assembly exercise.



You can access the GUNT Media Center via your QR code. There you will find EVERYTHING about the gearbox.



Suggestion for a useful preliminary or parallel experiment on the subject of damage detection and machine condition monitoring

Various types of damage to roller bearings can be precisely diagnosed through vibration analysis. The **PT501 Roller bearing faults experimental unit** enables fast and illustrative experiments. A selection of roller bearings is pre-damaged at strategic positions. Very powerful software illustrates the vibration spectra and provides data and reports.

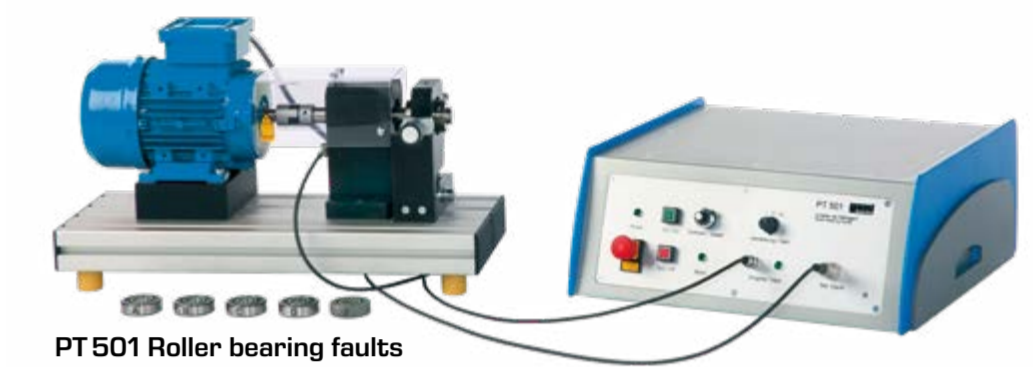
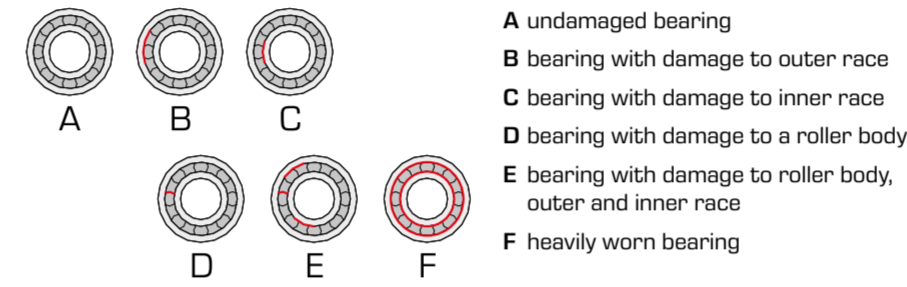

- an experiment that can be set up on a tabletop
- perfectly suited for independent work by students/trainees
- extensive presentation material is available for download, access via QR code
- precise operating instructions with detailed experiment illustrations are standard at GUNT
- we have prepared various bearings, each with one or more specific types of damage
- the shaft diameter for all bearings is 20 mm

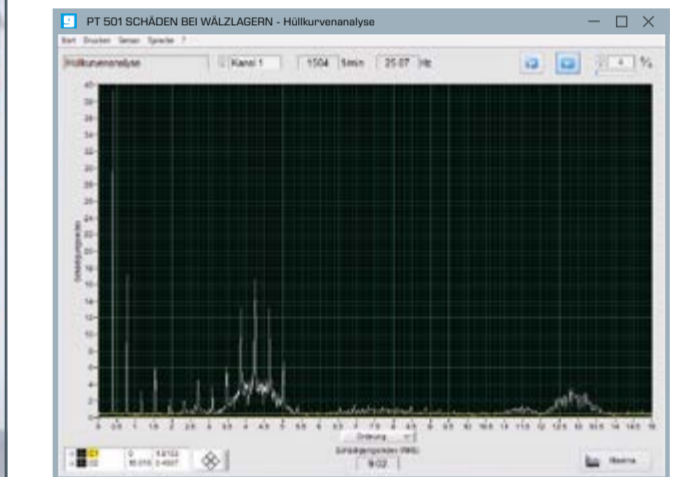

The GUNT software for vibration analysis allows versatile display and analysis options. Software and control unit are included in the scope of delivery.

3.1.3 | Learning objectives – competence modules

At this point we will look specifically at the learning objectives that are achievable or controllable within the scope of this exercise.

New learning objectives Digitalisation of the world of work	Standard learning objectives "traditional", technical content
<p>With the MT174 Sorting plant</p> <ul style="list-style-type: none"> ■ familiarisation with PLC with touch screen – HMI – as central control system for an industrial plant ■ navigate through the user interface menu and simulate and understand different maintenance scenarios ■ use assistance, simulation, diagnosis or visualisation systems ■ data handling in the context of the possibilities of the PLC ■ augmented reality (AR) in the service department ■ targeted information retrieval by means of QR code access ■ understand concepts of predictive maintenance and machine condition monitoring 	<p>With the MT174 Sorting plant</p> <ul style="list-style-type: none"> ■ investigate, understand and be able to describe the basic functionality of the plant ■ recognise and describe main components ■ recognise the components and functional areas where measures for machine condition monitoring are to be found ■ describe the components on which servicing and preventive maintenance are planned and how monitoring takes place ■ fundamental familiarisation with the concept of plant control
<p>With the PT501 Roller bearing faults experiment system</p> <ul style="list-style-type: none"> ■ install software for measurement data acquisition on single PC ■ familiarisation with and ability to use comprehensive measuring and display functions of an application for damage analysis ■ create, edit and distribute measurement reports via available communication channels ■ communicate, plan and work together in interdisciplinary teams 	<p>With the PT501 Roller bearing faults experiment system</p> <ul style="list-style-type: none"> ■ connect sensors to control and supply unit ■ install and align sensors ■ fit and remove various roller bearings ■ familiarisation with bearing types, bearing designations, bearing damage ■ familiarisation with different forms of representation and analysis that are used in the context of condition monitoring, based on vibration analysis

3 | Example presentation of selected exercises

3.2 | Assembly/disassembly of a gearbox

This exercise is mainly related to **process steps 6 and 8**. In order to show the didactic versatility of the DigiSkill 3 learning project, we use the MT 120 Assembly exercise: spur gear, which you will find with the same design in the MT174 Sorting plant.



3.2.1 | Overall aim of the exercise

If we assume that in our plant we are dealing with a large, expensive and long-lasting gearbox, then we it is clear that a complete overhaul process makes sense.

Then there is a clear work instruction what to do: scheduled disassembly, cleaning, inspection, replacement of defined parts, scheduled reassembly. This consideration can be transferred to a learning environment where purely technical goals are combined with multifaceted learning objectives.

Didactic consideration

The exercise starts with a fully assembled gearbox from the **MT120** Assembly exercise. This is a small, manageable gearbox that can be disassembled/assembled on a tabletop surface.

Disassembly is largely manual, without any particular use of jigs or special tools.

Didactically it makes sense to target other learning objective areas with this exercise:

- read and understand engineering drawings, terms of technical language, understand functionality, recognise and describe modules, distinguish between production and standard parts, identify materials, etc.
- using a comprehensive, digital information offer, the possibilities to address versatile, desired and required learning target areas with this exercise are endless...

3.2.2 | Examples with concrete steps

Example 1



MT120
Assembly exercise:
spur gear

Exercises

- advantages and disadvantages of spur gears
- FE method
- structure of roller bearings
- special features of a spur gear
- recognise components
- tolerances
- fits for roller bearings
- cast materials and corrosion
- involute toothing
- material designations
- assembly of roller bearings
- service life calculation of deep groove ball bearings
- torque ratio dependencies
- disassembly of a spur gear

This is an example of how a customer in Austria uses our **MT120 Assembly exercise: spur gear** to branch out into basic topics from design, machine elements, materials, etc.

The **MT120** unit serves as a practical reference and the GUNT Media Center provides an inexhaustible digital source of information. This is an openly designed lesson, with a demand for theory, even at higher education level.



This example is more didactically guided and with narrower learning objectives than the first. The assembly steps are illustrated. Either ordered by sequence, or not.

Task: Students/trainees arrange the steps into a meaningful sequence – assembly or disassembly – name the parts and describe each step.

Information source: GUNT Media Center.

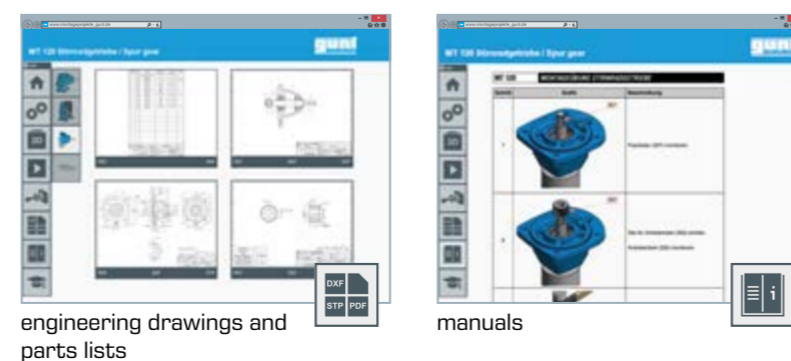

Example 2

Schritt	Grafik	Beschreibung	Schritt	Grafik	Beschreibung
22		Distanzscheibe (209) montieren.	28		Montagegruppe Abtriebsgehäuse (100) auf Vorrichtung 4 positionieren. Wichtig ist, die Montagegruppe bis zum Anschlag der Abtriebswelle in der Vorrichtung zu verschieben (Kippen vermeiden). Die waagerechte Lage der Dichtfläche erleichtert die Montage der Flachdichtung.
23		Rillenkugellager (210) entnehmen. Lagerstift einrücken.	29		Flachdichtung (102) auflegen. Dabei auf korrekte Ausrichtung der Flachdichtung auf den Gewindebohrungen achten.
24		Rillenkugellager (210) bis zum Anschlag aufschieben. Falls erforderlich, Vorrichtung 2 und Schraubhammer verwenden.	30		Montagegruppe Abtriebsgehäuse (101) ausrichten und auflegen.

exercise sheet with solutions

The GUNT Media Center

Access via QR code. Where you can find EVERYTHING. For teachers/trainers, of course, but especially for the students/trainees. Can be used with a laptop, tablet, smartphone.

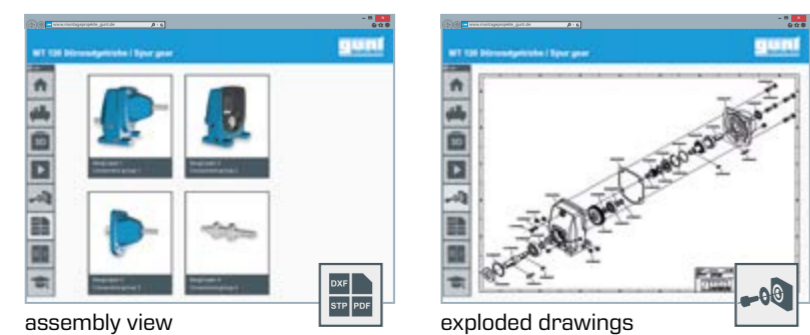

Example 3

This example is also concrete and practical.

Students/trainees are given the exploded view drawing of the gearbox without any names for the parts, and the parts lists.

Task: Using the parts list, the students/trainees have to identify the components and enter the item number in the exploded view.

Pos. Nr.	Einheit	Bezeichnung	Normen/Norm	Arbeitsnummer	Bemerkung
208	1	Fullgehoelze	MT120 10 02 001	430 0005 10 0001	EN-GLA-2001
209	1	Abtriebswelle	MT120 10 02 002	424 0304A0000	CASE
210	1	Driveshaft	MT120 10 02 003	400 1010A0000	S235JR
211	1	Distanzscheibe	MT120 10 02 004	445 1613A0001	St37
212	1	Sperrer	MT120 10 02 005	445 1613A0001	St37
213	1	Abtriebsgehäuse	MT120 10 02 006	445 1613A0001	St37
214	1	Abtriebsgehäuse	MT120 10 02 007	445 1613A0001	St37
215	1	Abtriebsgehäuse	MT120 10 02 008	445 1613A0001	St37
216	1	Abtriebsgehäuse	MT120 10 02 009	445 1613A0001	St37
217	1	Abtriebsgehäuse	MT120 10 02 010	445 1613A0001	St37
218	1	Abtriebsgehäuse	MT120 10 02 011	445 1613A0001	St37
219	1	Abtriebsgehäuse	MT120 10 02 012	445 1613A0001	St37
220	1	Abtriebsgehäuse	MT120 10 02 013	445 1613A0001	St37
221	1	Abtriebsgehäuse	MT120 10 02 014	445 1613A0001	St37
222	1	Abtriebsgehäuse	MT120 10 02 015	445 1613A0001	St37
223	1	Abtriebsgehäuse	MT120 10 02 016	445 1613A0001	St37
224	1	Abtriebsgehäuse	MT120 10 02 017	445 1613A0001	St37
225	1	Abtriebsgehäuse	MT120 10 02 018	445 1613A0001	St37
226	1	Abtriebsgehäuse	MT120 10 02 019	445 1613A0001	St37
227	1	Abtriebsgehäuse	MT120 10 02 020	445 1613A0001	St37
228	1	Abtriebsgehäuse	MT120 10 02 021	445 1613A0001	St37
229	1	Abtriebsgehäuse	MT120 10 02 022	445 1613A0001	St37
230	1	Abtriebsgehäuse	MT120 10 02 023	445 1613A0001	St37
231	1	Abtriebsgehäuse	MT120 10 02 024	445 1613A0001	St37
232	1	Abtriebsgehäuse	MT120 10 02 025	445 1613A0001	St37
233	1	Abtriebsgehäuse	MT120 10 02 026	445 1613A0001	St37
234	1	Abtriebsgehäuse	MT120 10 02 027	445 1613A0001	St37
235	1	Abtriebsgehäuse	MT120 10 02 028	445 1613A0001	St37
236	1	Abtriebsgehäuse	MT120 10 02 029	445 1613A0001	St37
237	1	Abtriebsgehäuse	MT120 10 02 030	445 1613A0001	St37
238	1	Abtriebsgehäuse	MT120 10 02 031	445 1613A0001	St37
239	1	Abtriebsgehäuse	MT120 10 02 032	445 1613A0001	St37
240	1	Abtriebsgehäuse	MT120 10 02 033	445 1613A0001	St37
241	1	Abtriebsgehäuse	MT120 10 02 034	445 1613A0001	St37
242	1	Abtriebsgehäuse	MT120 10 02 035	445 1613A0001	St37
243	1	Abtriebsgehäuse	MT120 10 02 036	445 1613A0001	St37
244	1	Abtriebsgehäuse	MT120 10 02 037	445 1613A0001	St37
245	1	Abtriebsgehäuse	MT120 10 02 038	445 1613A0001	St37
246	1	Abtriebsgehäuse	MT120 10 02 039	445 1613A0001	St37
247	1	Abtriebsgehäuse	MT120 10 02 040	445 1613A0001	St37
248	1	Abtriebsgehäuse	MT120 10 02 041	445 1613A0001	St37
249	1	Abtriebsgehäuse	MT120 10 02 042	445 1613A0001	St37
250	1	Abtriebsgehäuse	MT120 10 02 043	445 1613A0001	St37
251	1	Abtriebsgehäuse	MT120 10 02 044	445 1613A0001	St37
252	1	Abtriebsgehäuse	MT120 10 02 045	445 1613A0001	St37
253	1	Abtriebsgehäuse	MT120 10 02 046	445 1613A0001	St37
254	1	Abtriebsgehäuse	MT120 10 02 047	445 1613A0001	St37
255	1	Abtriebsgehäuse	MT120 10 02 048	445 1613A0001	St37
256	1	Abtriebsgehäuse	MT120 10 02 049	445 1613A0001	St37
257	1	Abtriebsgehäuse	MT120 10 02 050	445 1613A0001	St37
258	1	Abtriebsgehäuse	MT120 10 02 051	445 1613A0001	St37
259	1	Abtriebsgehäuse	MT120 10 02 052	445 1613A0001	St37
260	1	Abtriebsgehäuse	MT120 10 02 053	445 1613A0001	St37
261	1	Abtriebsgehäuse	MT120 10 02 054	445 1613A0001	St37
262	1	Abtriebsgehäuse	MT120 10 02 055	445 1613A0001	St37
263	1	Abtriebsgehäuse	MT120 10 02 056	445 1613A0001	St37
264	1	Abtriebsgehäuse	MT120 10 02 057	445 1613A0001	St37
265	1	Abtriebsgehäuse	MT120 10 02 058	445 1613A0001	St37
266	1	Abtriebsgehäuse	MT120 10 02 059	445 1613A0001	St37
267	1	Abtriebsgehäuse	MT120 10 02 060	445 1613A0001	St37
268	1	Abtriebsgehäuse	MT120 10 02 061	445 1613A0001	St37
269	1	Abtriebsgehäuse	MT120 10 02 062	445 1613A0001	St37
270	1	Abtriebsgehäuse	MT120 10 02 063	445 1613A0001	St37
271	1	Abtriebsgehäuse	MT120 10 02 064	445 1613A0001	St37
272	1	Abtriebsgehäuse	MT120 10 02 065	445 1613A0001	St37
273	1	Abtriebsgehäuse	MT120 10 02 066	445 1613A0001	St37
274	1	Abtriebsgehäuse	MT120 10 02 067	445 1613A0001	St37
275	1	Abtriebsgehäuse	MT120 10 02 068	445 1613A0001	St37
276	1	Abtriebsgehäuse	MT120 10 02 069	445 1613A0001	St37
277	1	Abtriebsgehäuse	MT120 10 02 070	445 1613A0001	St37
278	1	Abtriebsgehäuse	MT120 10 02 071	445 1613A0001	St37
279	1	Abtriebsgehäuse	MT120 10 02 072	445 1613A0001	St37
280	1	Abtriebsgehäuse	MT120 10 02 073	445 1613A0001	St37
281	1	Abtriebsgehäuse	MT120 10 02 074	445 1613A0001	St37
282	1	Abtriebsgehäuse	MT120 10 02 075	445 1613A0001	St37
283	1	Abtriebsgehäuse	MT120 10 02 076	445 1613A0001	St37
284	1	Abtriebsgehäuse	MT120 10 02 077	445 1613A0001	St37
285	1	Abtriebsgehäuse	MT120 10 02 078	445 1613A0001	St37
286	1	Abtriebsgehäuse	MT120 10 02 079	445 1613A0001	St37
287	1	Abtriebsgehäuse	MT120 10 02 080	445 1613A0001	St37
288	1	Abtriebsgehäuse	MT120 10 02 081	445 1613A0001	St37
289	1	Abtriebsgehäuse	MT120 10 02 082	445 1613A0001	St37
290	1	Abtriebsgehäuse	MT120 10 02 083	445 1613A0001	St37
291	1	Abtriebsgehäuse	MT120 10 02 084	445 1613A0001	St37
292	1	Abtriebsgehäuse	MT120 10 02 085	445 1613A0001	St37
293	1	Abtriebsgehäuse	MT120 10 02 086	445 1613A0001	St37
294	1	Abtriebsgehäuse	MT120 10 02 087	445 1613A0001	St37
295	1	Abtriebsgehäuse	MT120 10 02 088	445 1613A0001	St37
296	1	Abtriebsgehäuse	MT120 10 02 089	445 1613A0001	St37
297	1	Abtriebsgehäuse	MT120 10 02 090	445 1613A0001	St37
298	1	Abtriebsgehäuse	MT120 10 02 091	445 1613A0001	St37
299	1	Abtriebsgehäuse	MT120 10 02 092	445 1613A0001	St37
300	1	Abtriebsgehäuse	MT120 10 02 093	445 1613A0001	St37

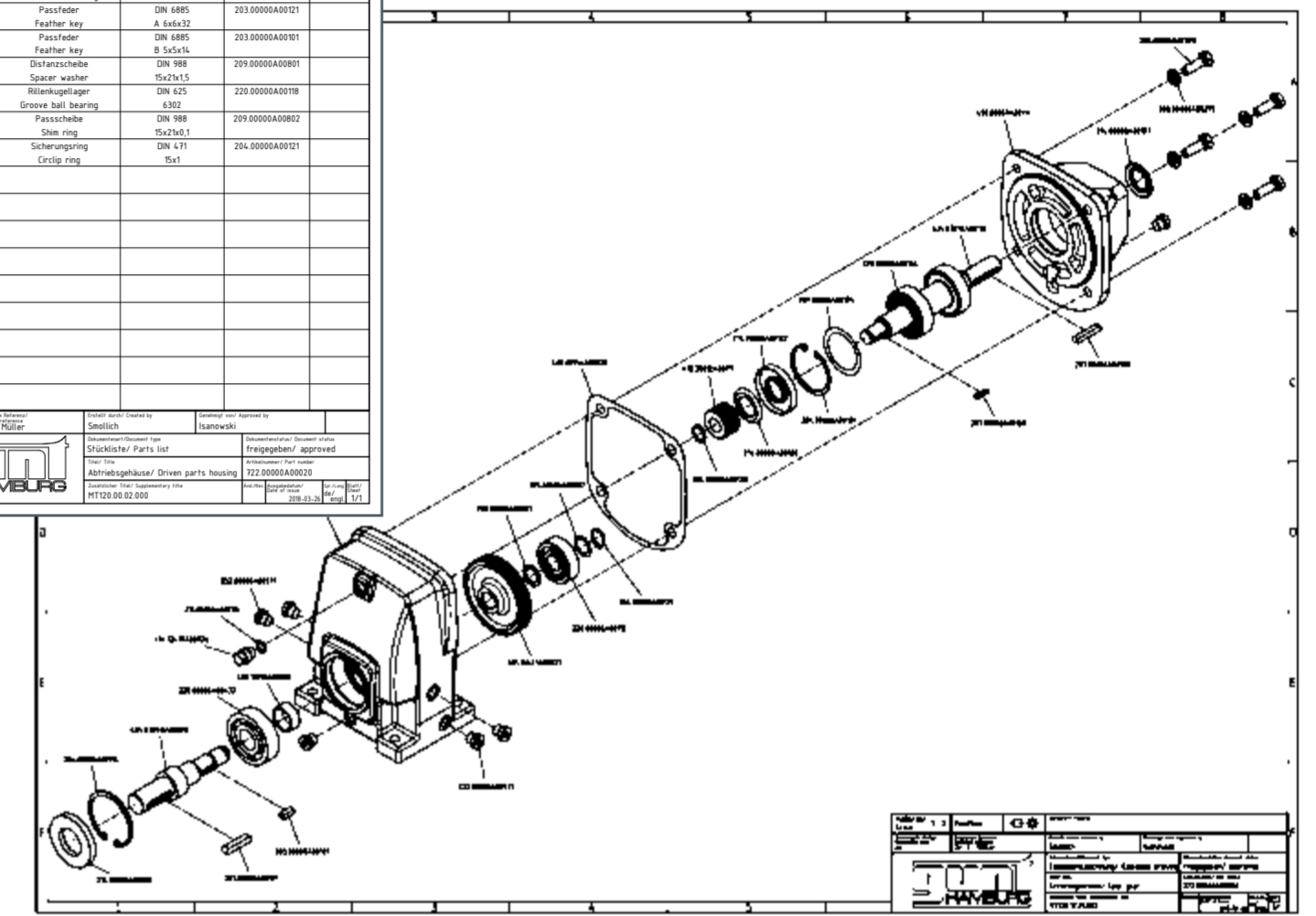

the illustration shows the solutions

Further didactic branches:

- recognise the assembly process from the exploded view and put it into a sequence
- is it possible to create modules that are pre-assembled and fed into the entire assembly process?

3.2.3 | Learning objectives – competence modules

At this point we will look specifically at the learning objectives that are achievable or controllable within the scope of this exercise.

New learning objectives
Digitalisation of the world of work

- accessing and handling digital data that can be accessed via a portal
- familiarisation with different file formats for technical documents, especially for drawings, such as PDF, DXF, STP
- familiarisation with and use of the comprehensive possibilities of a viewer tool for 3D models (STP), in this case Autodesk A360 Viewer
- familiarisation with the tools offered by the Viewer tool: measure, mark, annotate, explode model, sections
- access exercises in the portal, work on them with the help of interactive PDF templates
- access, download, send modules, parts drawings and parts lists, etc.
- use design data-supported assembly/disassembly videos

Standard learning objectives
"traditional", technical content

- understand and be able to describe the overall structure of a spur gear
- recognise and assign modules
- distinguish between production/drawing parts and standard parts
- be able to read and explain parts lists
- familiarisation with machine elements: shafts, gears (helical), feather keys, roller bearings, seals, etc.
- familiarisation with the technical terms, including in foreign languages if desired
- familiarisation with different metallic materials and understand their coding according to standards
- determine transmission ratio of the gearbox and know calculations for it
- recognise which components are particularly subject to wear and tear
- be able to plan and represent disassembly as a sequence
- draw up a tool and jig list for the tools required for disassembly/assembly
- replace wear parts and reassemble the gear
- produce a report on the work carried out, using standard software, explain it and also be able to forward it, by e-mail or by other digital means of communication

3 | Example presentation of selected exercises

3.3 | Functional test for quality assurance



This exercise is mainly related to **process step 9**.

3.3.1 | Overall aim of the exercise

The gearbox removed from the plant has now been completely overhauled and assembled. New parts have been installed.

The gearbox is subjected to a functional test in a special gearbox test stand that simulates **real conditions**. The test is carried out over a certain period of time and under specified loads. Finally, a test report is generated and used for documentation.

3.3.2 | Examples with concrete steps

Learning objectives and building blocks for competence development are derived from the examples.

Work is done with the **MT173 Test stand for gears** and one of these gear units:

- MT120 Assembly exercise: spur gear
- MT121 Assembly exercise: mitre gear
- MT122 Assembly exercise: planetary gear
- MT123 Assembly exercise: spur and worm gear



MT 173 Test stand for gears with MT 123 Assembly exercise: spur and worm gear

3.3.3 | Understanding the mechanical structure of the test stand and recognising basic functions

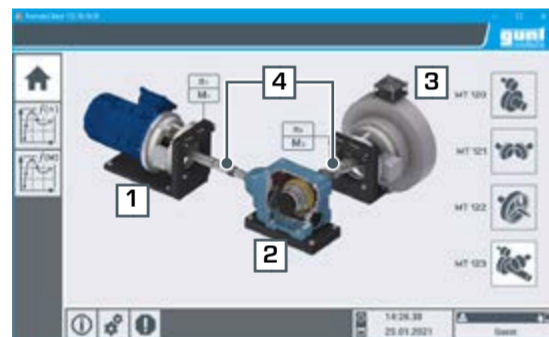

- 1 asynchronous motor, controlled, with speed and torque measurement via sensors
- 2 the gear unit under test, with foot plate for height compensation
- 3 loading device, magnetic particle brake, controlled excitation
- 4 coupling elements

The students/trainees describe the basic mechanical structure and determine the technical data of the components involved.

Essential additional technical information is available in the GUNT Media Center, such as for torque measurement and the magnetic particle brake.

3.3.5 | Installation of a gearbox and alignment of the whole system



The students/trainees have access to the engineering drawings of the overall assembly via QR code.

The control system itself also provides a picture of the overall assembly, but with less detail and not to scale.

Brackets and height compensation elements are needed for complete assembly of the system, depending on the type of gear.

The exact picture for this is provided by the retrievable engineering drawings.



The drawers of the **MT173** table contain everything needed for installation and alignment.

Didactic notes:

You do not have to work with a prepared, finished worksheet at this point. Have your students/trainees do the construction report and send it to you as a PDF by e-mail.

Another option is to have the students/trainees make a video of what they did.

You can also have them work on design and manufacturing tasks: the students/trainees sketch and manufacture brackets and compensation elements themselves.

3.3.4 | The control system



touch screen with PLC (HMI)

The students/trainees familiarise themselves with the control system: Functions, menus, settings, etc. and can describe and use them.

3.3.6 | Occupational safety – equipment safety

Occupational safety and equipment safety is always an indispensable element in every phase of training. Have students/trainees use the **MT173** Test stand for gears to determine which safety elements are present and under which conditions a test procedure can be started.

What to do if something unforeseen occurs and the test stand has to be stopped?



mechanical protection, input shaft/clutch, input side



emergency stop switch on the work surface



mechanical protection, output shaft/clutch, load side



main switch

3.3.7 | Connection of PC and mobile devices

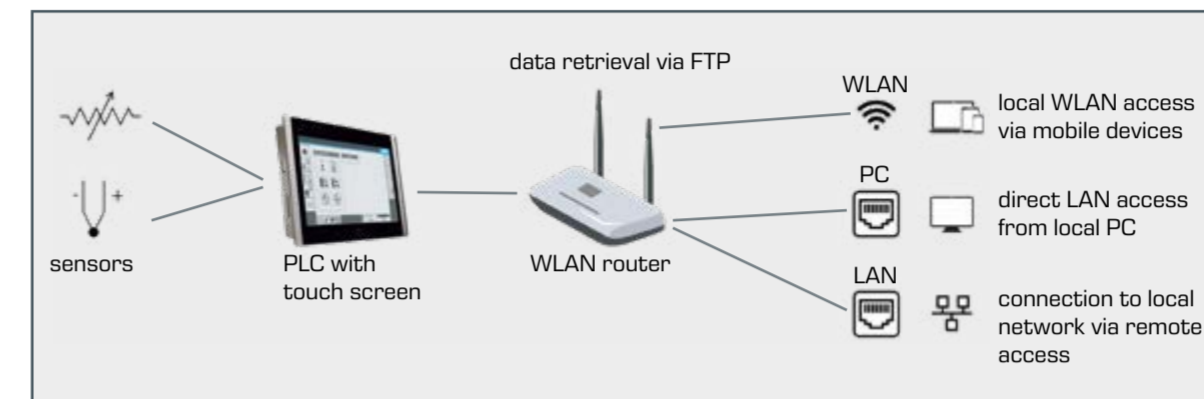

basic structure of the access options



connection ports on the side panel of the MT173 switch cabinet.



ethernet patch cable

This point offers you basic and comprehensive possibilities to get to know network, control and communication elements and structures and to apply them directly in practice.

In the MT173 test stand, an integrated PLC is responsible for the control and regulation tasks. All inputs, controls, regulation, measurement data acquisition and outputs are processed via this PLC. Direct data input and output is via touch screen.

Furthermore, the MT173 test stand is equipped with network technology that allows access via LAN and WLAN.

This gives you the following connection options:

- local WLAN access for mobile devices via an integrated WLAN router
- direct access for PC and laptops via a PC connection port (Ethernet) on the GUNT device
- connection to your local network via a LAN connection port (Ethernet) on the GUNT device

With these problems you lead your students/trainees directly into the heart of the necessary, practical digital applications.

Learning through actual real-world problems: there's no better way.

3.3.8 | Test results

The test sequence is automatically preset by the PLC. It is also possible to switch to manual operation. Screenshots can be saved, integrated into a test report, converted into other formats, or sent as a file. Graphical representations can be changed in many ways.

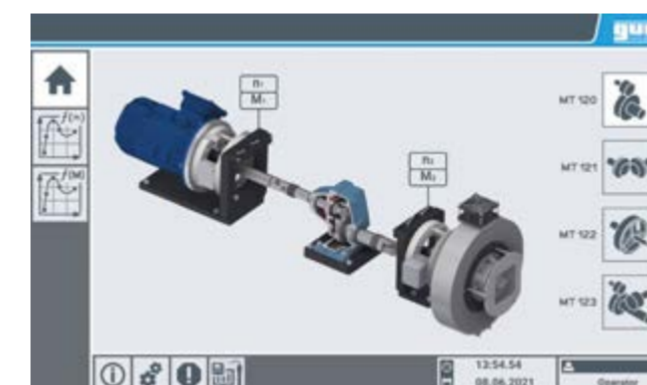

test setup for the MT120 spur gear

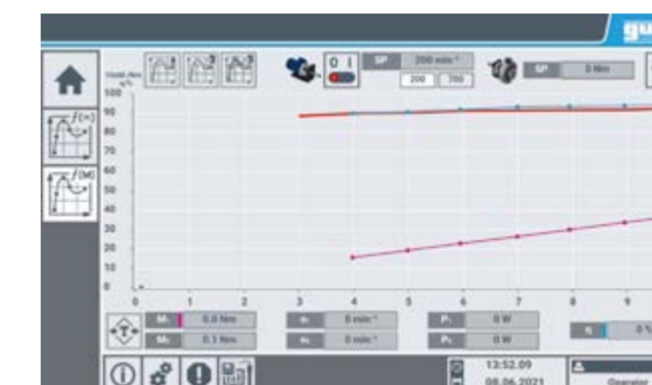

M = 4 - 10 Nm, n = 200 min⁻¹ = constant
upper curves, red: efficiency curve setpoint, blue: efficiency curve actual value

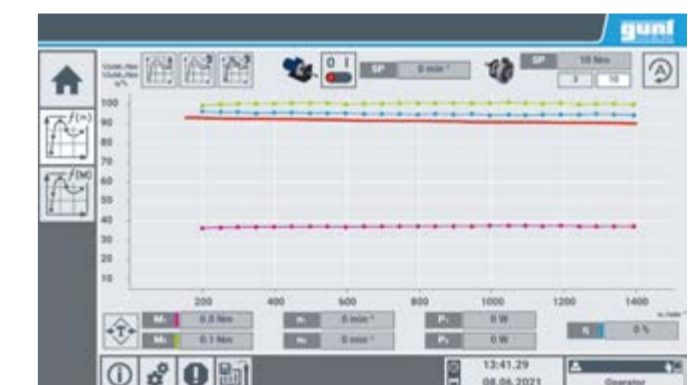

M = 10 Nm = constant, n = 200 - 1400 min⁻¹
upper curves, red: efficiency curve setpoint

3.3.9 | Learning objectives – competence modules

At this point we will look specifically at the learning objectives that are achievable or controllable within the scope of this exercise.

New learning objectives Digitalisation of the world of work

- familiarisation with modern automation components: PLC, sensors, etc.
- familiarisation with a PLC with HMI, functions, menus, settings, access further information via links
- retrieve assembly information, CAD data, drawings from a portal and use them in a specific manner
- understand and execute the test procedure via PLC menu navigation
- familiarisation with varied data communication structures: WLAN, LAN, screen mirroring
- familiarisation with data transfer via virtual FTP server
- understand network variants

Standard learning objectives "traditional", technical content

- understand and describe the overall structure and function of an automated test stand for gears
- understand details: controlled asynchronous motor, controlled load via magnetic particle brake, torque sensor and speed sensor
- understand the installation environment of the control system: open the switch cabinet, view and analyse the internal structure, read and understand electrical diagrams
- installation of a gear and alignment of the whole system
- commissioning
- understand the purpose of the test procedure, carry out the test procedure
- save and communicate test results
- know and apply measures for operational and occupational safety

3 | Example presentation of selected exercises

3.4 | Producing a spare part through additive manufacturing

This exercise is mainly related to process step 7.

3.4.1 | Overall aim of the exercise

Problem:

In this exercise, we assume that we do not have a required spare part, in this case a gear wheel, in stock and that it would take too much time to procure it. The gear wheel is therefore to be produced using the company's production facilities. CNC production, with metallic material? That would be the logical way. Or is it possible, as an alternative solution, to manufacture and install the gear wheel in another material and using additive manufacturing (3D printing)?

Our answer to the last question is yes and we continue with the introduction and implementation of spare part production using 3D printing.

The students/trainees deal with the work order for 3D printing, learn what data has to be provided for it and get a broad overview of the processes of additive manufacturing.

The students/trainees acquire knowledge about the materials used in 3D printing, manufacturing tolerances, strengths and load limits, any rework still required, etc.

3.4.2 | Detailed description of the procedure

For our example, we will take a gear wheel from the MT121 mitre gear.

The students/trainees access the GUNT Media Center via QR code and see what data is available for this gear. They identify the part using the parts list and individual parts drawing.

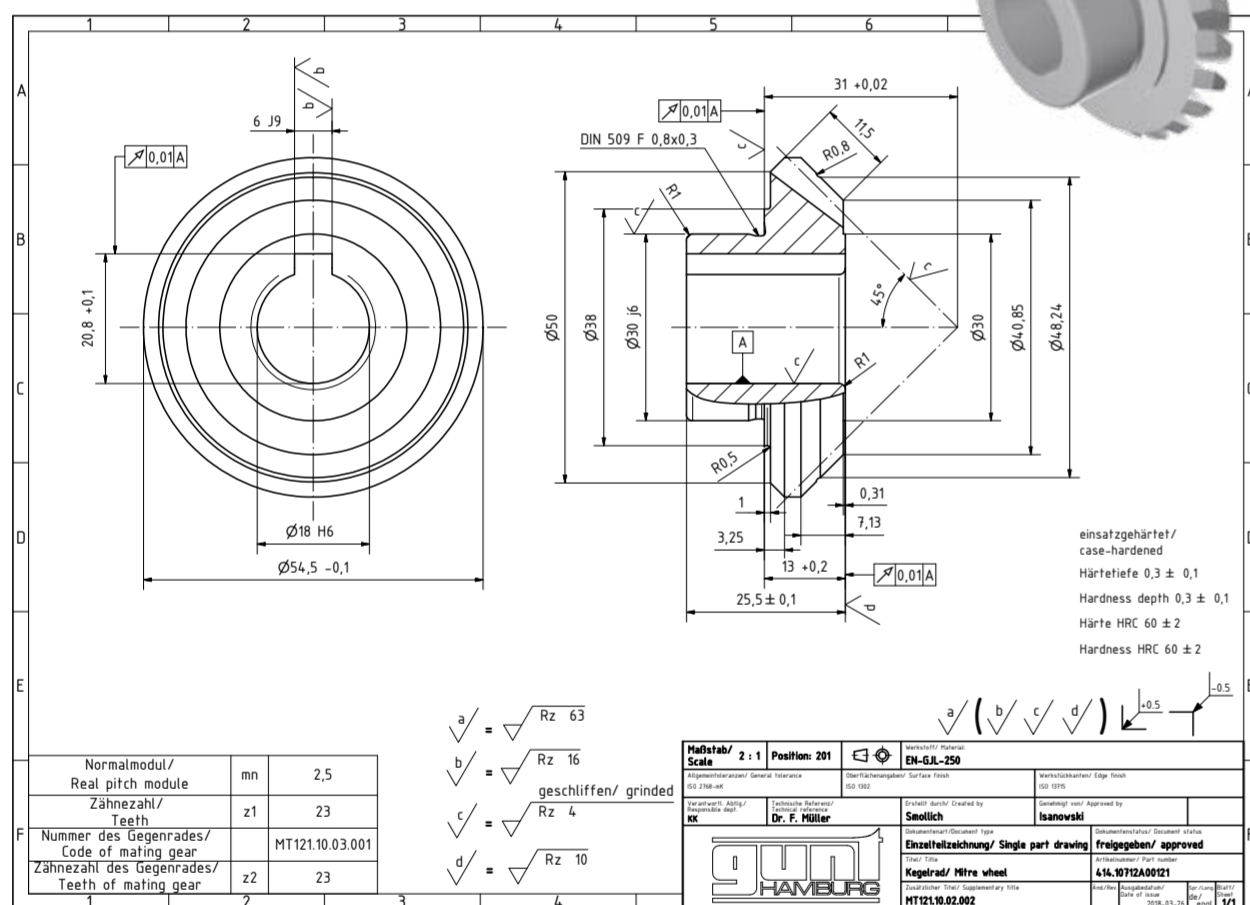

Pos.	Qty	Part	Description	Material	Part number	Assembly
100	1	gear	Abtriebsrad	HT121.03.001	414.1072A0002	100
101	1	gear	Drives shaft	HT121.03.002	414.1072A0001	100
102	1	gear	Abtriebsrad	HT121.03.003	414.1072A0001	100
103	1	gear	Abtriebsrad	HT121.03.004	414.1072A0001	100
104	1	gear	Abtriebsrad	HT121.03.005	414.1072A0001	100
105	1	gear	Abtriebsrad	HT121.03.006	414.1072A0001	100
106	1	gear	Abtriebsrad	HT121.03.007	414.1072A0001	100
107	1	gear	Abtriebsrad	HT121.03.008	414.1072A0001	100
108	1	gear	Abtriebsrad	HT121.03.009	414.1072A0001	100
109	1	gear	Abtriebsrad	HT121.03.010	414.1072A0001	100
110	1	gear	Abtriebsrad	HT121.03.011	414.1072A0001	100
111	1	gear	Abtriebsrad	HT121.03.012	414.1072A0001	100
112	1	gear	Abtriebsrad	HT121.03.013	414.1072A0001	100
113	1	gear	Abtriebsrad	HT121.03.014	414.1072A0001	100
114	1	gear	Abtriebsrad	HT121.03.015	414.1072A0001	100
115	1	gear	Abtriebsrad	HT121.03.016	414.1072A0001	100
116	1	gear	Abtriebsrad	HT121.03.017	414.1072A0001	100
117	1	gear	Abtriebsrad	HT121.03.018	414.1072A0001	100
118	1	gear	Abtriebsrad	HT121.03.019	414.1072A0001	100
119	1	gear	Abtriebsrad	HT121.03.020	414.1072A0001	100

parts list for assembly

Specific work order for the students/trainees:

Create a production order for part 414.1072. A00121: number of pieces, material, date, tolerances, production place, data.

Note: 3D production is based on the STP file. If a STP/STL conversion is required, you will find the conversion software in the GUNT Media Center.

Didactic tips

Manufacture parts in 3D printing from the huge selection of distinctive parts in the assembly exercises.

- MT 120 Assembly exercise: spur gear
- MT 121 Assembly exercise: mitre gear
- MT 122 Assembly exercise: planetary gear
- MT 123 Assembly exercise: spur and worm gear

Give students/trainees an overview of the enormous power of additive manufacturing: the possibility of complex shapes, cavities, intricate details, high strengths, different materials.

Another way of gaining good practical experience is to order 3D printed parts from a service provider via the internet. All you have to do is upload the STP file.

Didactically it can be said that it is not exclusively about the gear as a required spare part; many other elements of the four gears can be chosen for this exercise. It is about data, data formats, data flow and the characteristic features of additive manufacturing itself.



various 3D-printed parts from the Gears assembly exercises



Cutaway models

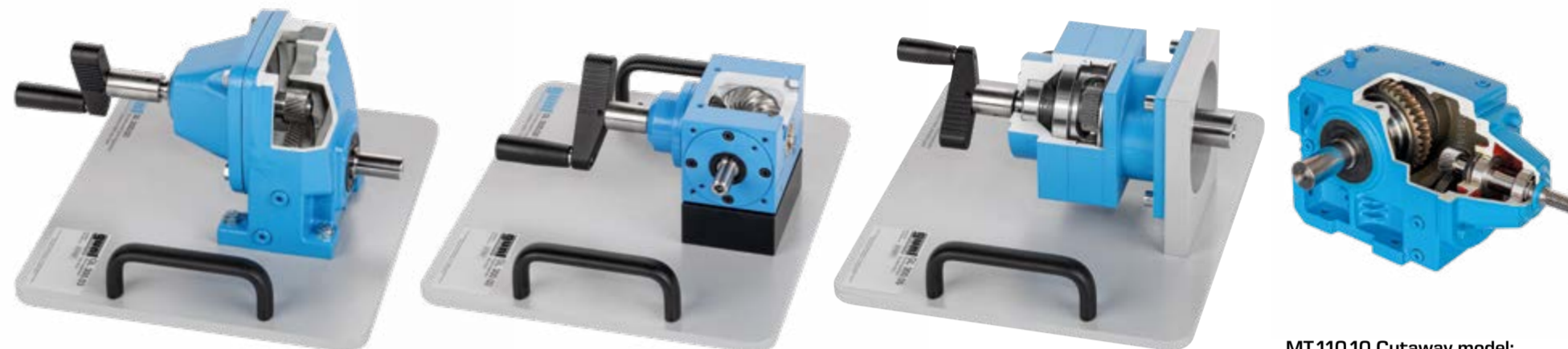

GL300.03 Cutaway model: spur gear GL300.02 Cutaway model: mitre gear GL300.05 Cutaway model: planetary gear MT110.10 Cutaway model: spur and worm gear

The four gears used in our GUNT DigiSkills 3 learning project are also available as functional cutaway models.

Determine the transmission ratios of the individual gears and check the formula.

The cutaway models facilitate introductory explanations and promote clarity thanks to the fully preserved motion functions. If you have the cutaway models available, in addition to showing/explaining/understanding, we also recommend a small exercise for the students/trainees.

$$i = n_1/n_2 = z_x/z_y$$

3D printing process



A simple printer fulfils its purpose in this exercise. See Chapter 4, product list.

The ideal work order with a high degree of independence for your students/trainees:

Produce part no. ... using additive manufacturing. Write a detailed report on what you did. Deliver the report by e-mail as a PDF attachment to your instructor.

3.4.3 | Learning objectives – competence modules

At this point we will look specifically at the learning objectives that are achievable or controllable within the scope of this exercise.

New learning objectives Digitalisation of the world of work	Standard learning objectives "traditional", technical content
<ul style="list-style-type: none"> create a work order: produce a spare part using 3D printing, use available digital tools, e.g. forms sort through and check information: GUNT Media Center, access via QR code, operating and service manual for the 3D printer know file formats for design documents: PDF, DXF, STP know which file formats are used for additive manufacturing know conversion programs that are used in 3D printing: STP/STL create and digitally transmit a production or purchase order for a required 3D-printed spare part 	<ul style="list-style-type: none"> understand what additive manufacturing is and what it can do know materials used in 3D printing; know some properties of these materials: strength, temperature limits, surface structure, etc. develop an understanding of additive manufacturing in order to assess application limits of 3D printed parts gain insight into unit costs and production time make comparisons with machining processes

3 | Example presentation of selected exercises

3.5 | Electrical engineering – control engineering

This exercise is not related to a specific process step. It can be targeted when "simulating" a fault on the **MT 173 Test stand for gears**.

3.5.1 | Overall aim of the exercise

Interdisciplinary cooperation in teams makes it necessary to open up strict technical boundaries. We propose to take the electrical and control engineering concept of the MT 173 test stand as a concrete practical example to introduce students/trainees in mechanics, electrics and electronics to these important topics.

- understand the overall function: controlled drive, asynchronous motor, magnetic particle brake as load, speed sensor, torque sensor, central control via PLC, touch screen as HMI
- understand circuit diagrams and parts lists, identify components, describe their function
- use the technical language; e.g. in English, identify and describe safety concepts

3.5.2 | Detailed description of the procedure

- 1 disconnect system from mains
- 2 open the switch cabinet at the rear
- 3 unfold the installation board

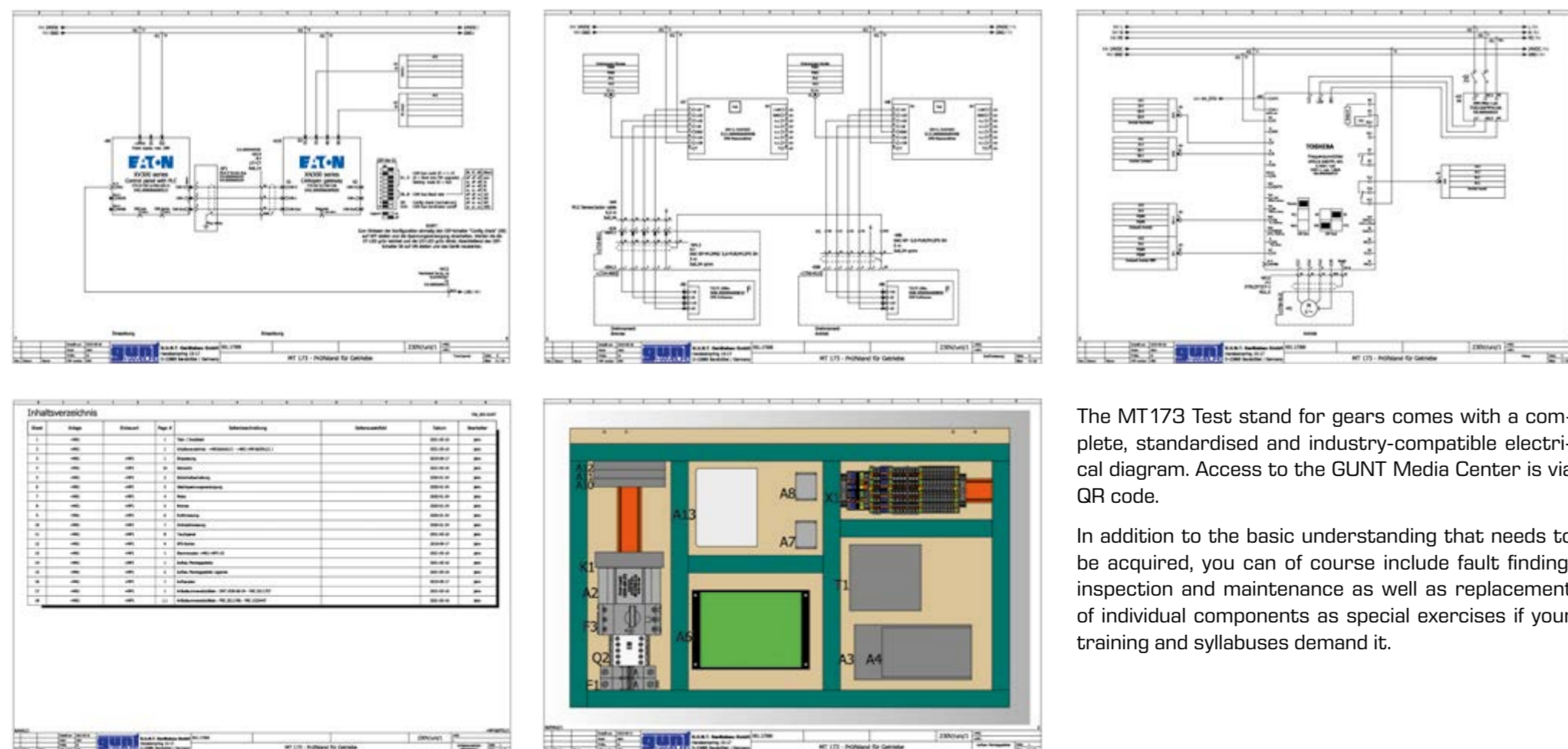

The MT173 Test stand for gears comes with a complete, standardised and industry-compatible electrical diagram. Access to the GUNT Media Center is via QR code.

In addition to the basic understanding that needs to be acquired, you can of course include fault finding, inspection and maintenance as well as replacement of individual components as special exercises if your training and syllabuses demand it.

4 | Product list and tender specifications

Product list

The following equipment is necessary for a fully equipped laboratory or workshop area:

Test stands or plants

- 1 x **MT 174 Sorting plant**
- 1 x **MT 173 Test stand for gears**

Assembly kits

- 5 x **MT 120 Assembly exercise: spur gear**
- 5 x **MT 121 Assembly exercise: mitre gear**
- 5 x **MT 122 Assembly exercise: planetary gear**
- 5 x **MT 123 Assembly exercise: spur and worm gear**

We recommend having five units in order to have five small groups working on one task at the same time. If this is not your plan, you can of course reduce the number of units.

Cutaway models

- 1 x **GL 300.03 Cutaway model: spur gear**
- 1 x **GL 300.02 Cutaway model: mitre gear**
- 1 x **GL 300.05 Cutaway model: planetary gear**
- 1 x **MT 110.10 Cutaway model: spur and worm gear**

Supplementary experiments on machinery diagnosis

- 1 x **PT 501 Roller bearing faults**

If you would like to expand on this topic, alternatively

- 1 x **PT 500 Machinery diagnostic system, base unit**
- 1 x **PT 500.01 Laboratory trolley**
- 1 x **PT 500.04 Computerised vibration analyser**
- 1 x **PT 500.15 Damage to gears kit**
- 1 x **PT 500.05 Brake & load unit**

Tender specifications

Here we provide text describing the overall concept of **GUNT DigiSkills 3**. The complete tender specifications for individual products can be found on the GUNT website, on the page for the specific product. We are always available to help you set up a call for tenders.

A practical exercise and learning concept for metalworking and electrical professions with the main topic: Maintenance and preventive maintenance on production plants. The GUNT DigiSkills 3 learning project illustrates a closed process, from the problem to the solution.

The starting point is a production plant, which in the GUNT DigiSkills 3 learning project is represented by an **automated sorting plant (MT 174)**. A certain gear contained in the plant is replaced. The removed gear is completely overhauled. Separate but technically identical gear kits and cutaway models are to be supplied for this sequence.

A semi-automated **test stand for gears (MT 173)** will be used for functional control and quality assurance.

As an important training element, certain spare parts are to be produced by additive manufacturing or CNC machining. The processes for this are prepared as part of the learning project.

For additive manufacturing

Laboratory 3D printer, order no. 609.0000A00185

Note

You can, of course, order the various products for a complete laboratory in stages if your available budget so requires.

You can start small and expand later.

Note:

Tablets, laptops, standard software, etc. are part of the basic equipment of your laboratories and training rooms. This type of equipment is not provided by GUNT unless you wish to procure a turnkey solution. We will be happy to help you with questions on topics such as access points, APPs, setting up screen mirroring, etc.

With the complete GUNT DigiSkills 3 system, the following building blocks for the **development of digital skills** must be achievable:

- maintenance routines on a production plant, digitally monitored and displayed by a **PLC from Siemens** via touch screen
- use of augmented reality (AR) for the planned maintenance steps on the sorting plant
- understand the concept of preventive maintenance and familiarisation with the fundamentals of machine condition monitoring
- information availability via a portal: data from the **GUNT Media Center**, accessed via QR code
- practical familiarisation with and ability to use file formats that are relevant in the engineering field: PDF, DXF, STP, STL, etc.
- use of different end devices, such as PC, laptop, tablet, smartphone, to retrieve information and to display processes
- develop an understanding of a closed, digital process sequence: ERP system or other database-driven information concepts
- familiarisation with additive manufacturing, understand and execute the necessary data transfer
- familiarisation with an automated gear testing process as a quality assurance element
- use standard software throughout, familiarisation with screen mirroring, make digital communication the standard
- understand and be able to describe the internationally used terms "condition monitoring" and "predictive maintenance"
- understand and be able to formulate basic concepts and characteristics of Industry 4.0

